



sabena [®] B707	Module: LWR FUS / EMPENA	A/C Reg :	Check :	 21F3000501
	Oper. : RT-MP LC			
	Type : STRUCT-INSP	Issuer : A59513	Cert.St.: 50516	
Spec. : MECHANIC	Release Date: 18.05.2010		Page 1 of 5	

FUSELAGE DRAINS INSP

Execution / Start Date:	
End Date:	

MAINT	RII/INSP

sabena B707	Module: LWR FUS / EMPENA	A/C Reg :	Check :	
	Oper. : RT-MP LC			
	Type : STRUCT-INSP	Issuer : A59513	Cert.St.: 50516	21F3000501
Spec. : MECHANIC	Release Date: 18.05.2010		Page 2 of 5	

FUSELAGE DRAINS INSP

					MAINT	RII/INSP
Nr.	Hardtime	Task	Spec.	Related Documents		
1.		E2 S	MEC	MMS-328 514120 01000 rev 15/05/01		
Check: B						
Zones: 100						
Access:						
NRC YES <input type="radio"/> NO <input type="radio"/>		IF YES, NUMBER(S):				

LWR FUSELAGE DRAINS:

1. STRUCTURE GENERAL DRAINAGE: (fig CPM Part II / 53-00-07)

FUSELAGE DRAINS EXTERNAL: INSPECTION OF ALL LOWER SURFACE OVERBOARD DRAINS, REMOVE DEBRIS & CONTAMINANTS.
CHECK THE FLAPPERS ON THE PRESSURIZED SKIN DRAINS FOR ALIGNEMENT & FREEDOM OF MOVEMENT.

sabena B707	Module: LWR FUS / EMPENA	A/C Reg :	Check :	 21F3000501 Page 3 of 5
	Oper. : RT-MP LC	Issuer : A59513	Cert.St.: 50516	
	Type : STRUCT-INSP	Release Date: 18.05.2010		
Spec. : MECHANIC				

FUSELAGE DRAINS INSP

MAINT RII/INSP

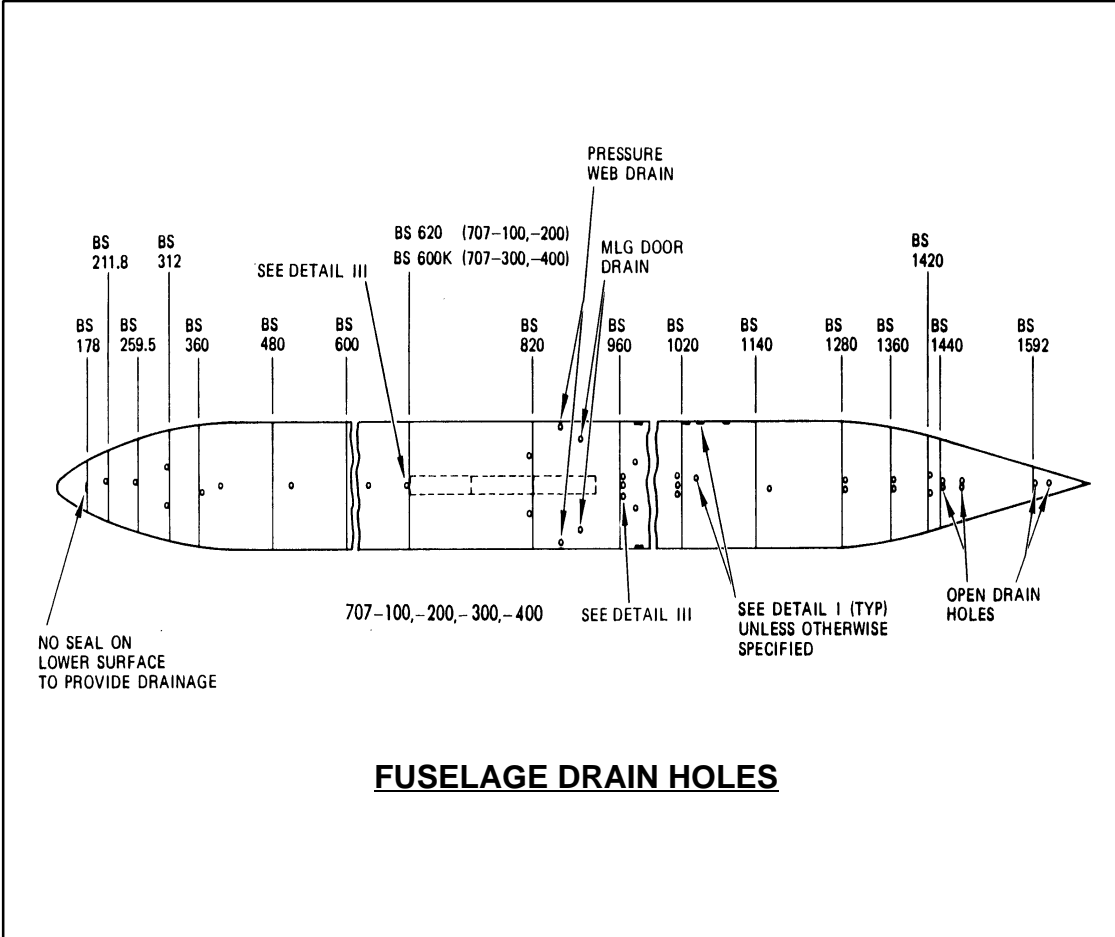

sabena B707	Module: LWR FUS / EMPENA	A/C Reg :	Check :	 21F3000501 Page 4 of 5
	Oper. : RT-MP LC	Issuer : A59513	Cert.St.: 50516	
	Type : STRUCT-INSP	Release Date: 18.05.2010		
Spec. : MECHANIC				

FUSELAGE DRAINS INSP

MAINT RII/INSP

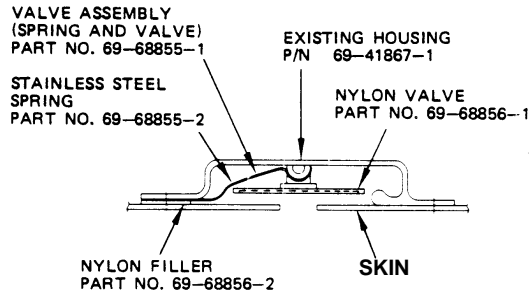
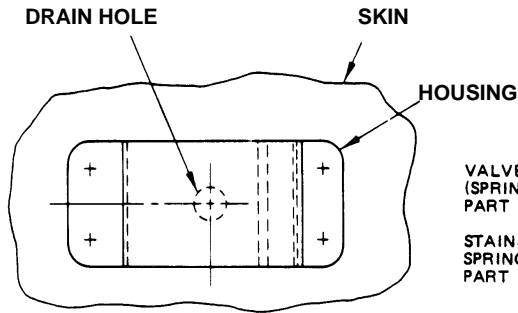

IMPROVED DRAIN VALVE

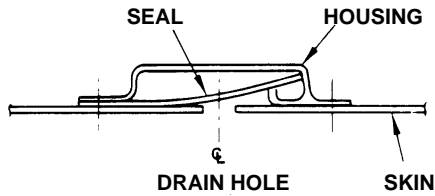

ORIGINAL DRAIN VALVE

TYPICAL DRAIN VALVE INSTALLATIONS

DETAIL I

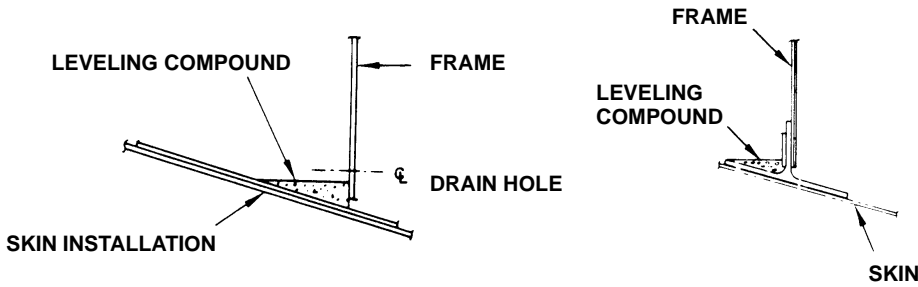

TYPICAL USE OF LEVELING COMPOUND

DETAIL II

sabena B707	Module: LWR FUS / EMPENA	A/C Reg :	Check :	 21F3000501 Page 5 of 5
	Oper. : RT-MP LC	Issuer : A59513	Cert.St.: 50516	
	Type : STRUCT-INSP	Release Date: 18.05.2010		
Spec. : MECHANIC				

FUSELAGE DRAINS INSP

MAINT RII/INSP

